

Evaluation of a Continuous-Indexing Vacuum Belt Filter As a Replacement for Filter Presses For the Manufacture of a High-Value Specialty Chemical Product

The BHS Continuous-Indexing Vacuum Belt Filter (CI-VBF) with 12 m² of filter area replaced a 440 m² filter press. The CI-VBF provided improved washing efficiency for a higher quality product, and lower operating and lower maintenance costs with a fully automated operation.

By Barry A. Perlmutter, President & Managing Director

Technical Report
Report Number 030304-101654

Evaluation of a Continuous-Indexing Vacuum Belt Filter As a Replacement for Filter Presses For the Manufacture of a High-Value Specialty Chemical Product

The BHS Continuous-Indexing Vacuum Belt Filter (CI-VBF) with 12 m² of filter area replaced a 440 m² filter press. The CI-VBF provided improved washing efficiency for a higher quality product, and lower operating and lower maintenance costs with a fully automated operation.

By Barry A. Perlmutter, President & Managing Director

Introduction

Solid-liquid separation can be accomplished by pressure or vacuum filtration in a batch or continuous mode. Generally, following filtration, the cake must be washed and subsequently dried. The choice of technology depends upon a wide range of parameters of the solids (i.e. crystal size and distribution, type and shape), liquids (type, temperature, and viscosity) and the process itself. This article discusses the evaluation and installation of the BHS Continuous-Indexing Vacuum Belt Filter (CI-VBF) as a replacement for manually operated filter presses.

Current Operation & Process Problems

This specialty chemical plant currently uses four (4) filter presses for production of six (6) different high-valued products. Each filter press contains 136 plates with a filter area of 4400 square feet (440 m²). The plant was experiencing operating and process problems as follows:

- Low washing efficiencies (very high wash liquid usage and high wash ratios) to meet a conductivity specification
- High final moisture of the cake which requires more drying time
- Frequent filter media blinding and high maintenance costs for media change out
- High operating costs as the cake discharge from the filter presses is a manual operation
- Difficulty in handling the wet cake discharge which requires frequent operator intervention
- Mixing of the mother liquor and wash filtrates which increases the cost of distillation and recovery

The plant engineers were given a Six-Sigma project to improve the overall process. The evaluation consisted of centrifuges, nutsche filters and vacuum belt filters (moving tray, rubber belt and continuous-indexing designs). The criteria for evaluation included: continuous operation, multiple washing stages in the forward and counter-current modes, easy to clean, cake compression, thermal

drying features to recover drier solids and minimize the amount of equipment needed (i.e. reduced capital expenditures for the project). In this application, the product cake is compressible. The concern is that a deep cake on a nutsche filter-dryer would have long cycle times and potential of cloth blinding. This same concern surfaced about the cycle times and cloth blinding on centrifuges. In addition, washing of the cake was critical and tests showed inefficient washing results on filter-dryers and centrifuges. Finally, the team had the objective of a continuous operation. In summary, then, the conclusion of this first evaluation stage was that the use of a thin-cake vacuum belt filter (VBF) would be the preferred technology. Before pilot testing could begin, the second phase of the evaluation occurred comparing the three different designs of the VBF technologies. Table 1 illustrates the decision making process for the VBF designs.

Based upon the above evaluation, the BHS design of CI-VBF, shown in Figure 1 (on page 4), was selected for further bench-top and pilot testing.

Table 1: Comparisons of Vacuum Belt Filter (VBF) Technologies

Component	Continuous-Indexing	Moving Tray	Rubber Belt	Comments
Rubber belt and sealing belts	Not required	Not required	Required; movement is by an external motor	Increased maintenance and spare part costs; increased water usage (30%) for belt sealing and lubrication
Moving Trays	Not required, trays are fixed in place	Required	Not Required	Rails and rollers to maintain and lubricate, flexible hoses for the filtrate outlets are difficult to reach and may require an enclosed space entry.
Slurry Feeding	Gentle; eliminates splashing; oscillating feed zone is possible	Inclined feed plate	Inclined feed plate	CI-VBF employs a controlled feed for complete tray coverage and even cake buildup.
Cake Washing	Efficient displacement wash as belt is stopped; residence time can be maximized	Continuous	Continuous	CI-VBF employs spray balls, nozzles or overflow for washing; cake washing is controlled and efficiency maximized
Multiple Stages of Cake Washing	Yes	Yes	Yes	Possible with all designs.
Separation of mother liquors and wash filtrates	Yes; trays and filtrate outlets are fixed so each filtrate can be recovered separately	No; filtrates are mixed making recovery difficult	No; filtrates are mixed making recovery difficult	CI-VBF allows for recovery of the mother liquor and filtrates; recirculation and reuse is easily accomplished.
Mechanical Cake Compression	Yes, belt is stopped	Yes, design requires a squeezing belt against the discharge roller which also rubs the cake	No	CI-VBF allows for mechanical squeezing of the cake
Drying by Vacuum	Yes	Yes	Yes	In some cases, vacuum levels may be higher in CI-VBF
Drying by hot gas blowing or steaming	Yes; belt is stopped which allows for steam or gas to be directly injected into the cake; can be used with open designs	Yes, heats up air space but not the cake directly; requires a hood	Yes, heats up air space but not the cake directly; requires a hood	CI-VBF provides for maximum drying efficiency in open or pressure-tight designs
Filter Belt Cleaning	Yes	Yes	Yes	CI-VBF units can employ difference methods of belt cleaning including from above and below the belt, high-pressure spray nozzles; wash water is only used when the belt is moving; the wash water is stopped when the belt is stopped which reduces water / solvent usage.
VBF Cleaning	Easy to clean	Difficult	Difficult	CI-VBF units eliminate extra hardware and belt components for easy cleaning; automated clean-in-place designs without operator intervention are possible.

CI-VBF Technology

Figure 2 illustrates, in practical terms, the operational features of the CI-VBF. The operation is further described in the following paragraphs. In the CI-VBF, the slurry feed is continuous while the filter cloth is moved intermittently; the trays are fixed in place. For cloth movement, the vacuum is broken by butterfly valves and the cloth moves (indexes), by pneumatic cylinders, in the space above the vacuum trays. The belt moves along and relaxes while indexing, which allows for long filter cloth life. The CI-VBF eliminates the need for rubber carrier belts and motor to move the filter media. Further, compared with moving tray designs, the CI-VBF requires no additional hardware such as rails, rollers and flexible pressure-vacuum rated hoses that are within the belt filter frame.

For the process operation, due to the stepwise operation of the belt, washing and drying efficiencies are maximized, as the belt is stopped

and the mechanism of “plug-flow” for gases and liquids is in effect. Finally, because the trays are fixed, the mother liquor and the wash filtrates can be recovered individually and recirculated and/or recovered and reused which allows for a more efficient overall operation.

After filtration, washing and drying, the cake is discharged and the filter media is cleaned. Cleaning occurs only when the filter belt is moving which ensures maximum cleaning with lower liquid usage. Automated valves control the washing. The clean filter media is then conveyed back to the slurry feed zone.

The entire operation is pneumatic and easily controlled by a PLC or customer distributed control system (DCS), which minimizes the installation, mechanical commission, water batching and process startup time. The CI-VBF units can be enclosed, dust-tight, or pressure tight for inerting or gas-blanket and are manufactured in stainless steel, Hastelloy, synthetic or reinforced - synthetic components

depending upon the solvents, solids, temperatures, etc. The CI-VBF turnkey systems include feed pumps, liquid transfer and recirculation pumps, separator and receiver tanks, liquid ring vacuum pumps, instrumentation, pre-piped and pre-wired skids and PLC control systems. Heating and cooling packages for liquids and/or gases and solids handling can also be included.

Preliminary Tests in the BHS Laboratory

The preliminary bench-top tests were conducted in the BHS laboratory. For this testing, the BHS pressure-vacuum rated Pocket-Leaf Filter (PLF) with 20 cm² of filter area is used. The PLF is shown in Figure 3 and is used to gather vacuum filtration data as well as washing and drying data.

PLF Testing Procedures and Results

The first optimization is the time for vacuum filtration. A pre-measured amount of slurry is added at the top, vacuum is applied and the amount of filtrate is recorded. Parameters that are varied in this step include cake depth and the filter media. The objective of this step is to minimize the vacuum filtration cycle time and minimize and/or eliminate the amount of solids (fines) lost in the filtrate. The testing showed that thin-cake vacuum filtration in the 8 - 10 mm range with a 7 micron filter media can meet these objectives.

Following filtration, displacement washing is tested. As discussed above, in the CI-VBF, the belt is stopped and the mechanism of plug-flow displacement washing

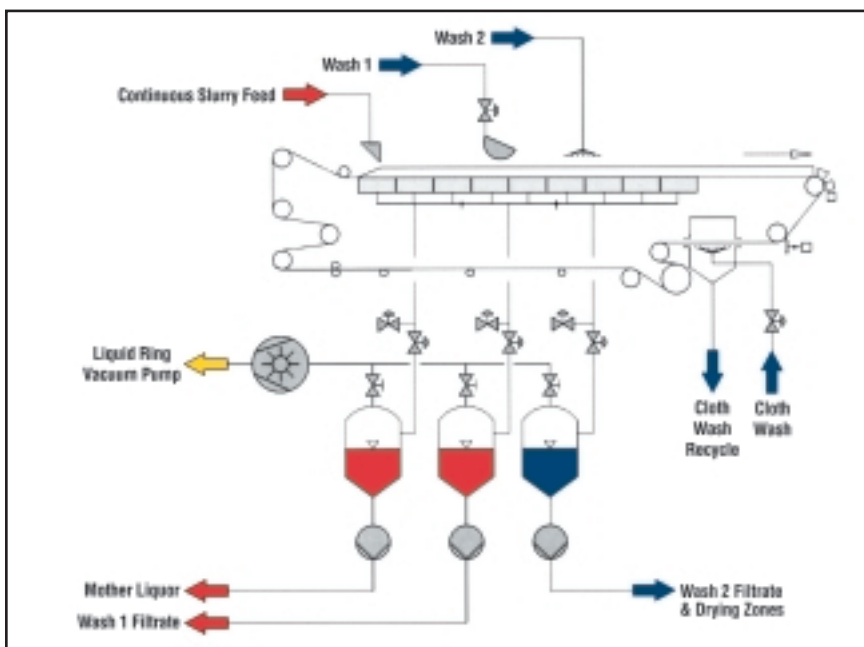

Figure 1. BHS Continuous-Indexing Vacuum Belt Filter (CI-VBF)

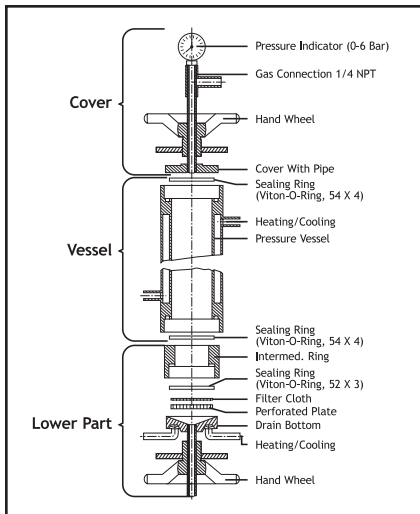

Figure 3. BHS Pocket-Leaf Filter (PLF)

occurs. This is simulated in the PLF. The washing tests have the objectives to minimize the wash ratios (maximum washing efficiency) while consistently meeting the conductivity specification. The impact of temperature was also tested along with forward and counter-current washing. The results showed that forward flow washing at 60° C is the optimum process condition.

In the CI-VBF, cake compression is possible as the belt is stopped and a mechanical compressing device can be incorporated. This is simulated in the PLF with a gas-assisted “pressing-plug.” Due to the compressibility of the cake, cake compression was not successful.

The last process step is drying. Vacuum is applied with and without gas blowing. Further, the gas can be heated or at ambient temperatures. Several iterations are required to determine the optimum time and final moisture content.

Finally, cake discharge is determined qualitatively by the BHS process engineer based upon visual indications and experience. In this case, the cake easily came off the filter media with no residual heel.

Scale-Up from the PLF Data

For the process scale up and guarantee, the BHS process engineer along with customer selects the most representative test results. The scale-up procedure is shown in Table 2.

In summary, the scale-up yielded a belt filter area of 18 m² to meet

the required production rate. This result, combined with the benefits of the CI-VBF clearly indicated that a technology change would be a significant improvement to the operation. Secondly, based upon BHS experience, PLF tests generally are more conservative and yield a larger filter area than pilot scale tests.

Table 2: Scale-up Procedure	
Filter Performance (liters/m ² /minute) =	$\frac{\text{Sample Volume}}{(\text{PLF Area} * \text{Filtration Time})}$
Total Area Required to Meet the Production Rate = A_t	
$A_t = \text{Sum of the Filtration area } (A_f) + \text{Washing Area } (A_w) + \text{Drying Area } (A_d)$	
$A_f = \text{Production Rate} / \text{Filter Performance}$	
$A_w = \text{Total Washing Time} / (\text{Filtration Time} * A_f)$	
$A_d = \text{Total Drying Time} / (\text{Filtration Time} * A_f)$	

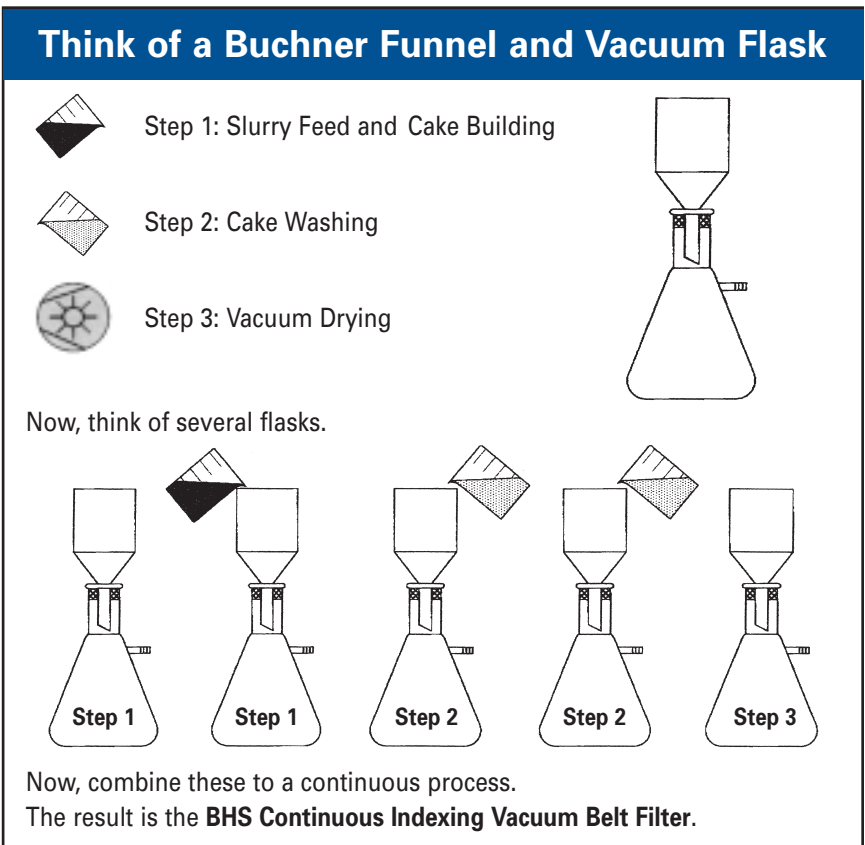

Figure 2. CI-VBF Operational Features

Conclusion and Path Forward Steps from the Preliminary PLF Test Data & Scale-Up

Based upon the above results and scale-up, which demonstrated that the product could be vacuum-filtered, washed with a 20% reduction in the wash ratios while meeting the conductivity requirement, and dried, the decision was to continue with pilot scale testing. These tests would have the following objectives:

1. Confirm the filtration, washing and drying results
2. Determine the required size of the CI-VBF
3. Demonstrate the product quality
4. Allow the plant operators to see the CI-VBF in operation.

Pilot-Scale Tests at the Customer's Plant Site

The choice of the pilot-scale belt filter is dependent upon the process parameters, material of construction and other considerations.

Figures 4 and 5 show the two BHS pilot units that are available for on-site testing: 0.3 m² and the 0.8 m² designs. Both units are configured

for automatic-pneumatic operation and are fed directly from a reactor vessel. They are equipped with a vacuum station, filtrate receiver tanks, liquid transfer / recirculation pumps and a pneumatic control system. For pilot tests, pneumatic controls allow for quick and easy installation without concern for the electrical classification of the building. An explosion-proof, class 1, div. 1, groups C & D motor runs the vacuum pump. The 0.3 m² unit is all stainless steel and contained in a pressurized housing for gas inerting. The 0.8 m² design is all polypropylene and an open design. The decision was to use the 0.8 m² design, as containment was not required.

Pilot-Scale Testing Scale-Up Results & Discussion

The main objectives of the tests were to verify the PLF tests results and scale-up and to determine if the cake exhibited any tendencies to form cracks. Table 3 illustrates the Data Collection Form used in the pilot tests. The scale-up calculation is performed as previously described. The required area, from the process scale-up, is then increased to include trays for feeding and discharge. The total required area from the pilot scale tests showed that an 12 m² CI-VBF, including a built-in safety factor for increased production, would meet

the current and future production needs of the plant.

The Six-Sigma team concluded the following:

1. The CI-VBF can meet the current and future production requirements
2. Based upon the plant actual process requirements, a 12 m² CI-VBF would be required
3. The pilot-scale testing demonstrated that a smaller CI-VBF could be used for the current production needs
4. The PLF tests accurately predicted the performance of the 0.8 m² pilot scale unit in terms of washing efficiencies to meet the conductivity objective
5. The washing ratios are more than 20% less than the current operation yielding a savings of water and water disposal
6. Automated cake discharge eliminates operator invention and provides the associated cost savings
7. The filter media washing is very efficient and filter media blinding and the subsequent costs for media change out can be eliminated
8. Each filtrate can be collected separately allowing the processing (recovery and reuse) of the filtrates to be very economical

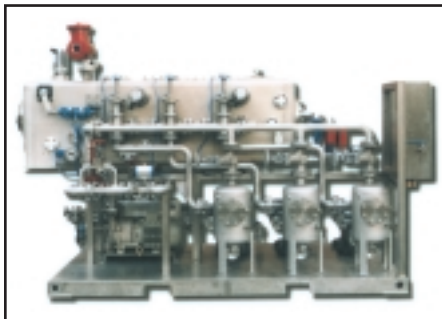

Figure 4. BHS 0.3 m² pilot-scale CI-VBF

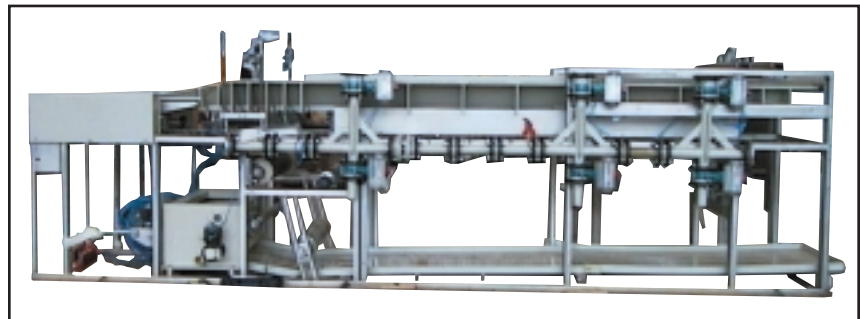

Figure 5. BHS 0.8 m² pilot-scale CI-VBF (Vacuum & filtrate package is on a separate skid, not shown)

9. Changing slurry flow rates, solids compositions and multiple products are easily accommodated by the indexing design of the CI-VBF via a PLC program
10. The CI-VBF can be easily cleaned due to the fixed tray design as there is no additional hardware components that are in the process area
11. Enclosed design allow for containment of the product, filtrates and wash liquids and eliminated operator exposures

Installation & Summary

The Six-Sigma team studied centrifuges, nutsche filters and three designs of vacuum belt filters to improve the current operation that used manually-operated filter presses. The evaluation had several stages from initial investigation, bench-top testing and finally pilot-scale testing. The BHS

Continuous-Indexing Vacuum Belt Filter (CI-VBF) with 12 m² of filter area was the selected technology to replace a 440 m² filter press. The CI-VBF provided improved washing efficiency for a higher quality product and significantly lower operating and maintenance costs with a fully automated operation. The return-on-investment (ROI) calculation allowed the project to be funded with a payback in the range of 3- 6 months.

BHS provided the total process solution for the plant. The CI-VBF turnkey system, as shown in the P & ID in Figure 6, included liquid transfer and recirculation pumps, separator and receiver tanks, liquid ring vacuum pump, instrumentation, pre-piped and pre-wired skids and PLC control system. The time from delivery through installation, mechanical commissioning, water-batching and process startup was approximately three (3) weeks. The CI-VBF is currently producing validated product and meeting the specific production objectives of the plant.

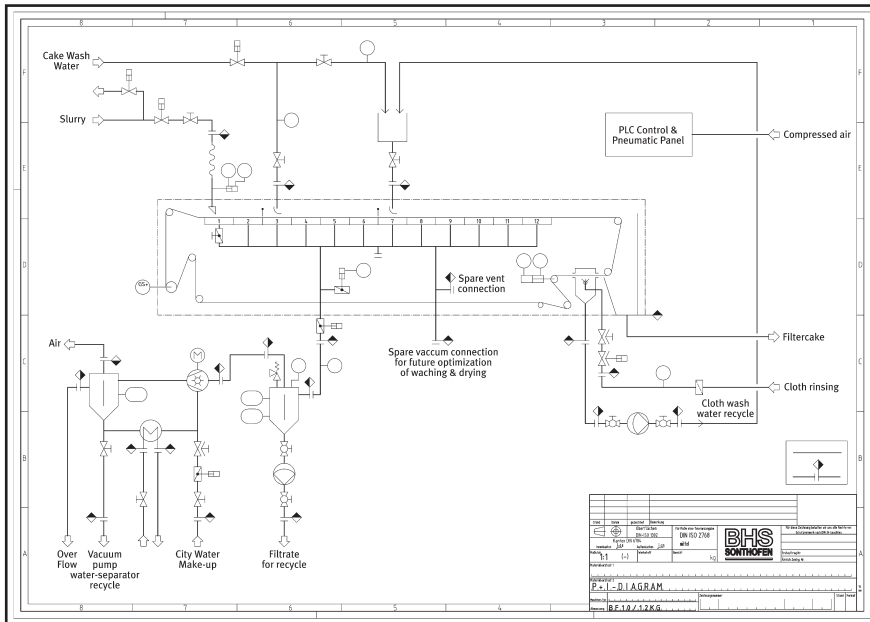

Figure 6. Typical BHS P & ID of a complete turnkey installation

Table 3: BHS Data Collection Form For CI-VBF Pilot-Scale Test

Test Data				
Customer: _____		Report #: _____		
Date: _____		Test Unit: _____		
		Run #1	Run #2	Run #3
Set-Up Info:	Indexing Time sec			
	Stopped Time sec			
	Indexing Length mm			
	Vacuum mbarg			
Suspension	Name			
	Density of Slurry			
Feeding	Feed Rate of Slurry			
	Temperature of Feed			
	Number of Filtration Zones			
	% Solids in Filtrate			
Wash 1	Wash Material			
	Flowmeter Reading of Wash			
	Actual Wash Flow Rate			
	Temperature			
	Number of Wash 1 Zones			
Wash 2	Wash Material			
	Flowmeter Reading of Wash			
	Actual Wash Flow Rate			
	Temperature			
	Number of Wash 2 Zones			
Total Wash	Total Wash Ratio in liters wash per liter of feed			
Drying	Pressure on Pressing Device			
	Temperature			
	Number of Drying Zones			
Cake	Wet Cake Mass Rate			
	Dry Cake Mass Rate			
	Residual Moisture %			
	Thickness mm			
	Cake Quality			

Specializing in Thin-Cake Filtration, Cake Washing & Drying Technologies

Test in the BHS Laboratory or at Your Plant for the Optimum
Process Technology



BHS Rotary Pressure Filter

- Continuous thin-cake (0.25-6 inches) production
 - Filtration is conducted via pressure of up to 90 psig
 - Positive displacement washing or counter-current washing
 - Multiple washing steps as well as solvent exchanges, steaming and extraction
 - Cake drying by blowing hot or ambient-temperature gas
 - Atmospheric discharge from pressure operations for direct discharge to downstream equipment
-



BHS Autopress

- The Autopress is installed in potent compound and active pharmaceutical ingredient (API's) facilities as well as for specialty chemical applications
 - Thin-cake, typically 0.25-1.0 inches, production
 - Filter plates are contained in a pressurized filter housing for complete containment
 - Batch pressure filtration and forward or reverse flow washing
 - Vacuum or hot-gas drying or pre-drying without agitation or tumbling
 - Mechanical compression to 600 psig to eliminate cake cracking
 - Fully automatic, heel-free and contained product discharge
 - CIP systems with documented performance based upon Riboflavin tests
-



BHS Belt Filter

- Continuous filtration, washing and drying
 - Thin-cakes between 0.25-4 inches
 - Multiple washing zones for forward or counter-current washing to 99.99% purity
 - Drying to 0.1% moisture with heated trays and mechanical compression
 - Materials include stainless steel, Hastelloy and synthetic materials
 - Gas-tight and pressurized housings
-

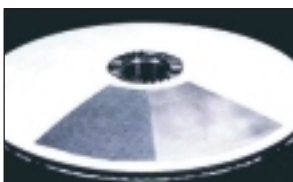

BHS Pressure Plate Filter

- Horizontally designed for stable cakes
 - Possible pre-coating of the media with activated carbon or diatomaceous earth
 - Vibrating plates, along with gas-assist pulsing, provide for automatic discharge
 - Effective solids discharge without spinning-plates
 - No rotating or mechanical seals
-



BHS Candle Filter & Inverting Filter

- Pressure filtration, clarification and heel filtration
 - Specialized candles with perforated metallic or synthetic cores
 - Filter media to less than 1 micron
 - Cake washing produces a uniform cake for drying
 - Cake discharge via gas blowback for the candle filter
 - Possible pre-coating of the media with activated carbon or diatomaceous earth
 - Cake discharge by inverting filter cloth for heel-free discharge and final moisture content to 1% for the inverting filter
-

BHS-Filtration Inc.

9123-115 Monroe Road, Charlotte, NC 28270 • Tel 704.845.1190 • Fax 704.845.1902
e-mail: info@bhs-filtration.com • internet: www.bhs-filtration.com

BHS-Filtration Inc. is a subsidiary of BHS-Sonthofen

Hans-Böckler-Straße 7 • D-87527 Sonthofen, Germany • Tel 49.8321.802.200 • Fax 49.8321.802.320 • www.bhs-sonthofen.de